

DRIVERS SHORT OPERATING INSTRUCTIONS – DTCO 1381

Display and Operating Elements

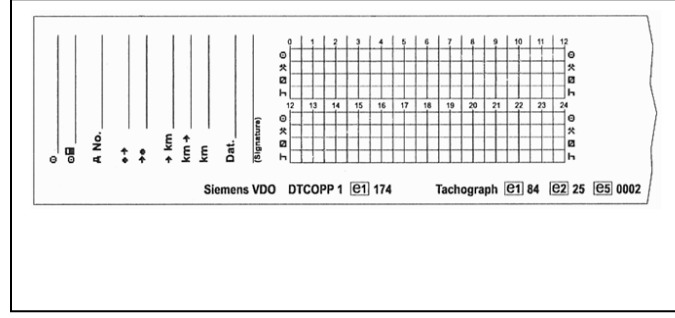
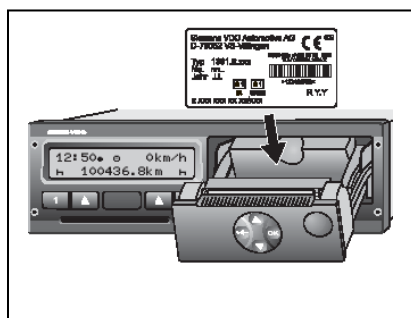
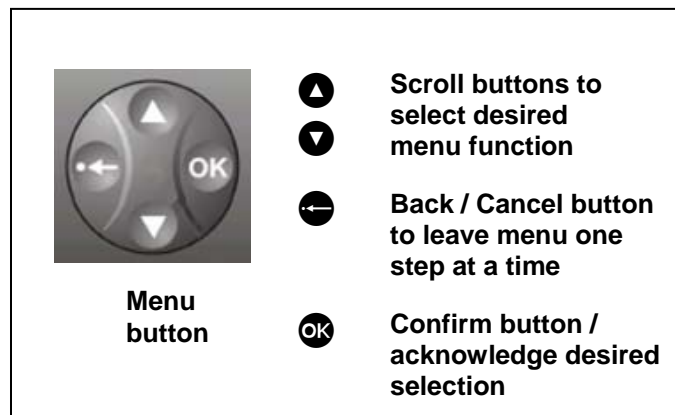
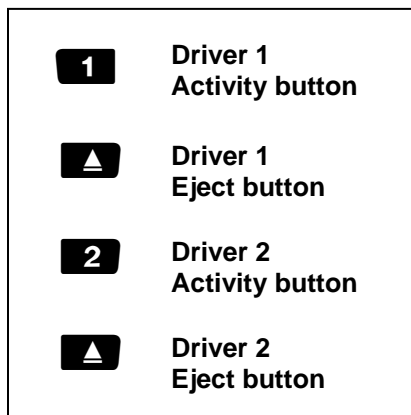
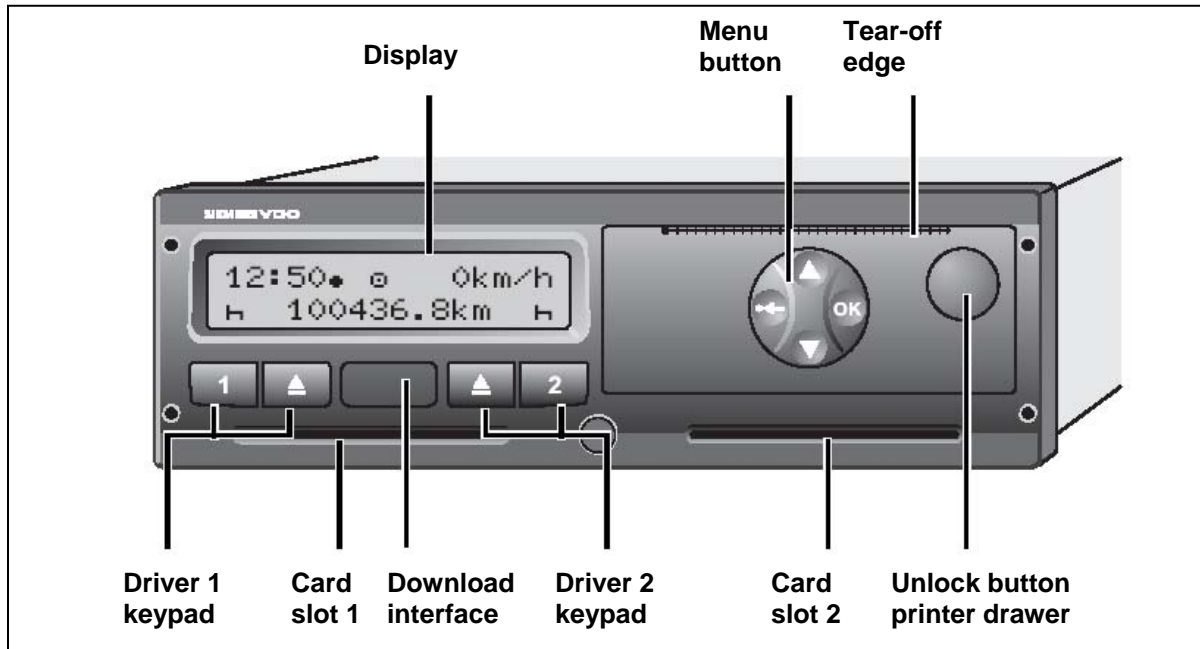

After opening the printer drawer, the data plate is visible showing 'e1 84'. Any printer paper used must also show on the reverse side "e1 84".

UTC Time (Universal Time Co-ordinated)

The digital tachograph and driver card saves all time entries (including manual entries) for mode activities in UTC time. Also, all time information on printouts is shown in UTC time

UK and Ireland

Converting Local Time to UTC:

During Winter Time UTC = Local Time
During Summer Time UTC = Local Time – 1hr

Converting UTC Time to Local Time:

During Winter Time Local Time = UTC Time
During Summer Time Local Time = UTC Time + 1 hr

Local Time Set

The symbol "●" appears after the time

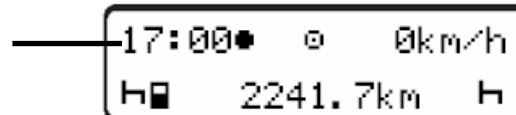

UTC Time

The time appears without the symbol "●" i.e. when UTC = local time

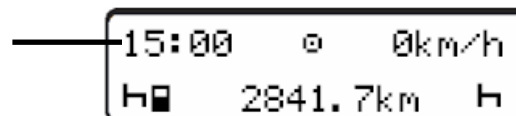

Mode Activity Behaviour

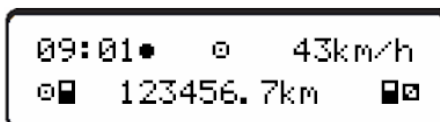

Whilst driving the digital tachograph switches automatically to the following activities:

- for driver 1 activity "●"
- for driver 2 activity "■"

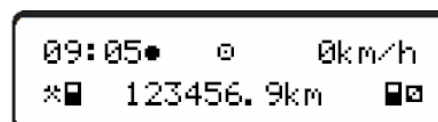

When the vehicle stops, the digital tachograph switches automatically to the following activities:

- for driver 1 activity "●"
- for driver 2 activity "■"

Driver Card Log-in Procedure

- 1) Switch on the vehicle's ignition (pre-release 1.2 version unit and ADR variant)
- 2) Insert Driver Card with the **chip facing upwards and the arrow pointing forwards** into Card Slot 1

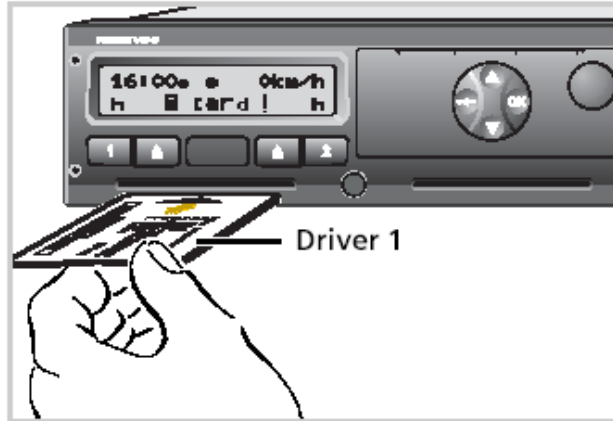

- 3) Menu guidance after inserting driver card (with no manual entries):

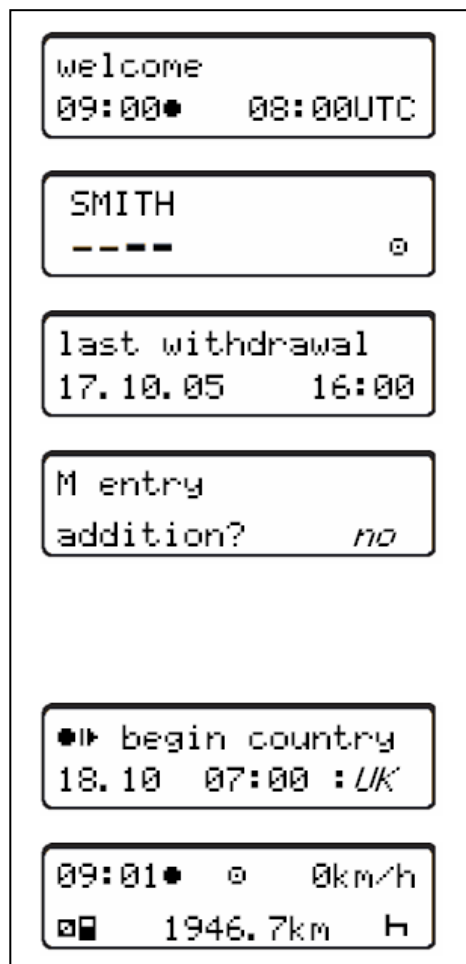

Greeting text; the set local time (09:00) and the UTC time (08:00) will appear for approx. 3 secs

The driver's name appears. A progress bar indicates that the driver card is being read

The date and time of the previous card withdrawal will be displayed in UTC time for approx. 4 secs

Manual Entries menu (Working away from the vehicle without the driver card inserted):
Select "no" if you do not want to add any mode activities
Select "yes" if you want to add mode activities



Select Country at the beginning of the shift and acknowledge



The standard display will appear

Driver 1 Card Log-off Procedure

- 1) Turn on the vehicle's ignition
- 2) Enter the corresponding activity; i.e. at the end of the shift to **H**
- 3) Press the eject button  for card slot 1
- 4) Menu guidance after ejecting driver card 1:

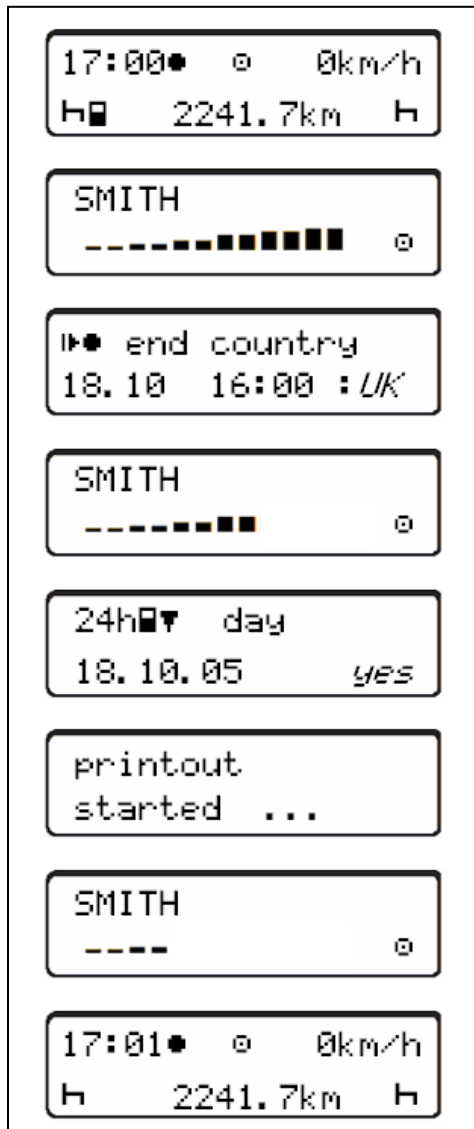

The driver's name appears. A progress bar indicates that the digital tachograph is transferring data to the driver card

Select Country at the end of the shift and acknowledge



Continues writing to the driver card

If you require a printout, select "yes" otherwise select "no" and then acknowledge



If a printout is selected, the display indicates that the printout has started

Continues writing to the driver card

The driver card is released and the standard display appears

Driver Card and Vehicle Unit Printout Operation

Main Menu – Driver 1 Card Printout

- 1) Turn on the vehicle's ignition
- 2) Press **OK** button
- 3) Select the following functions step by step:

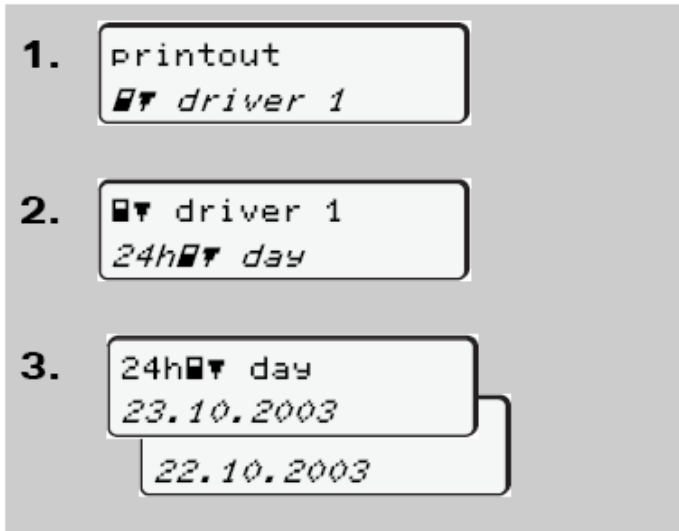

Press **OK**

Press **OK**

Press **OK** to printout current day or Press **▼** to scroll to a previous day

Please note that a Driver Card Printout for the current day can be selected when logging off with the Driver Card

Main Menu – Vehicle Unit Printout

- 1) Turn on the vehicle's ignition
- 2) Press **OK** button and press **▼** twice
- 3) Select the following functions step by step:

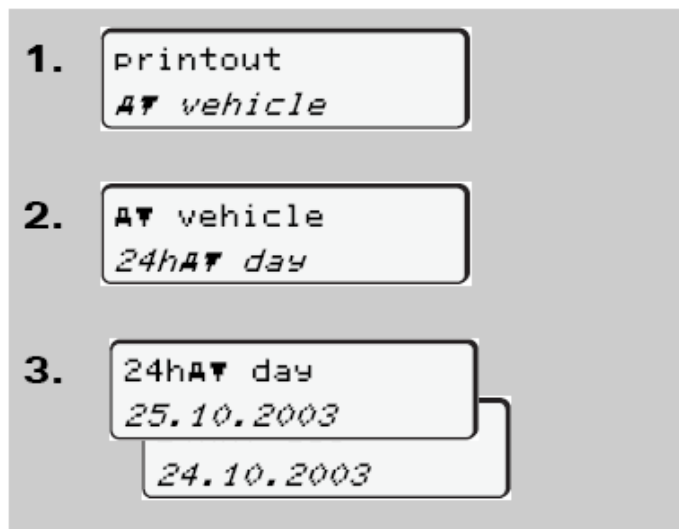

Press **OK**

Press **OK**

Press **OK** to printout current day or Press **▼** to scroll to a previous day

Driver Card Printout Example

| | |
|---|--|
| <pre> SIEMENS VDO Automotive ▼ 18.10.2005 16:00 (UTC) -----▼ 24h▼ ----- 0 James Brian 0UK /45678901234567 7 8 ----- 0 Smith John 0UK /DB051241420304 0 0 04.01.10 ----- A 34596UBN78ERUYUA6 UK / EF54 EKV ----- B Siemens VDO Automotive AG 1381.2050100001 ----- T Browns Tacho Centre ----- TUK /WBT0F340111125 0 0 T 01.08.2005 ----- 0UK /45678901234567 7 8 0 01.10.2005 13.10 ▼ ----- 18.10.2005 74 ----- ? 00:00 07:00 07h00 0 07:00 07:30 00h30 * 07:30 08:00 00h30 ----- 1 A UK / EF54 EKV 1 946 km * 08:00 09:06 01h06 0 09:06 10:25 01h19 H 10:25 11:08 00h43 0 11:08 14.23 03h15 H 14.23 15:25 01h02 * 0 15:25 15:46 00h21 0 15.46 16:00 00h14 2 241 km; 295 km ----- ? 16:00 ----- ● 07:00 UK 1 946 km ● 16:00 UK 2241 km 0 04h48 295 km * 01h36 0 00h51 H 01h45 ? 07h00 00 00h00 ----- x x !# 1 12.10.2005 17:31 (6) 01h21 ----- --- ● 0 0</pre> | <p>Date and time in UTC</p> <p>Daily printout of driver activities from the Driver Card</p> <p>Enforcement Officer card holder</p> <p>Driver and Card identification</p> <p>Vehicle identification including VIN, issuing Member State and VRN</p> <p>Identification of the DTCO 1381</p> <p>Most recent calibration including name of Workshop, Workshop Card identification and date of calibration</p> <p>Most recent Control Check including date and time of control and type (i.e. printing)</p> <p>Date of the activities shown and usage counter (i.e. 74 days that the card was used)</p> <p>Time period that the card was not inserted and manual entries</p> <p>Activities while card was inserted (* indicates a rest period of at least an hour)</p> <p>Time period that the card was not inserted</p> <p>Summary</p> <p>List of the five most recent saved events or faults on the driver card</p> <p>List of the five most recent saved events or faults in the DTCO 1381</p> <p>Handwritten information: Location of Control Signature of enforcement officer Signature of the driver</p> |
|---|--|

Inserting a New Print Roll into the Digital Tachograph

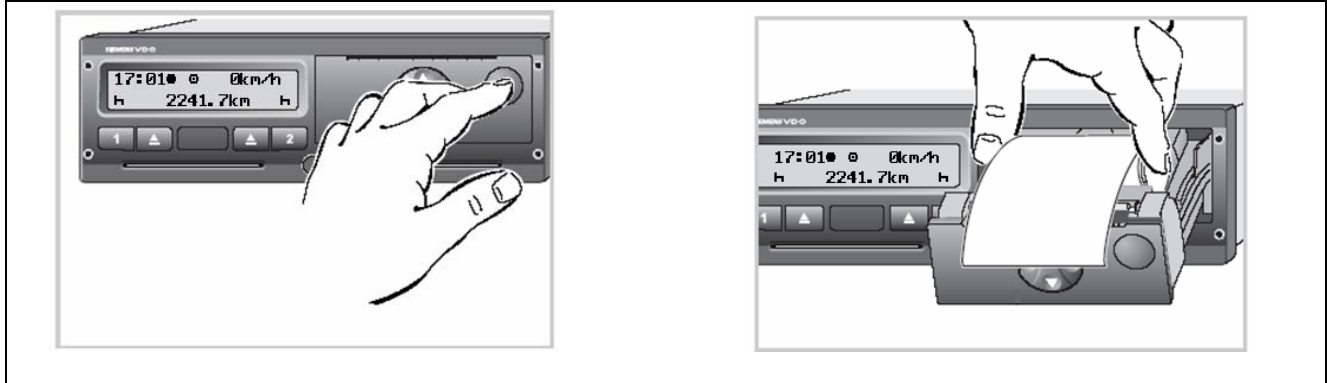

Menu Structure

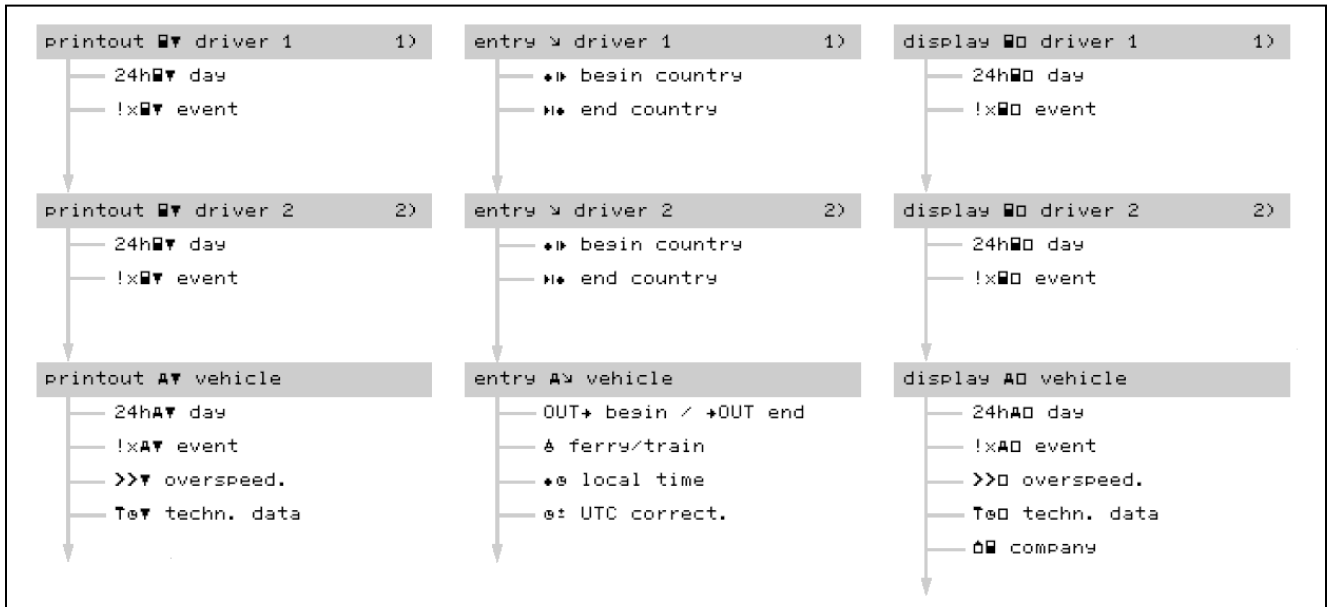

Common Pictograms

| | | |
|----------------------|--|---|
| Driving time | Period of Availability | Break and rest time |
| Other Work Time | Valid interruption / break | Unknown time |
| Tachograph card | Printer | Display |
| Vehicle unit | | |
| Event | Fault | 24h▣▾ Daily driver activities from the driver card |
| Driving without card | 24h▣▾ Daily driver activities from the Vehicle Unit | |

Manual Entries

Example shown - Working away from the vehicle without the driver card inserted

Driver card was inserted on 18/10/05 at 08:00 with the following manual entries:

- Adding ½ hr on to the end of the shift 17/10/05 from 16:00 to 16:30 UTC
- Prefixing ½ hr and ½ hr on to the start of the shift 18/10/05 from 07:00 to 08:00 UTC

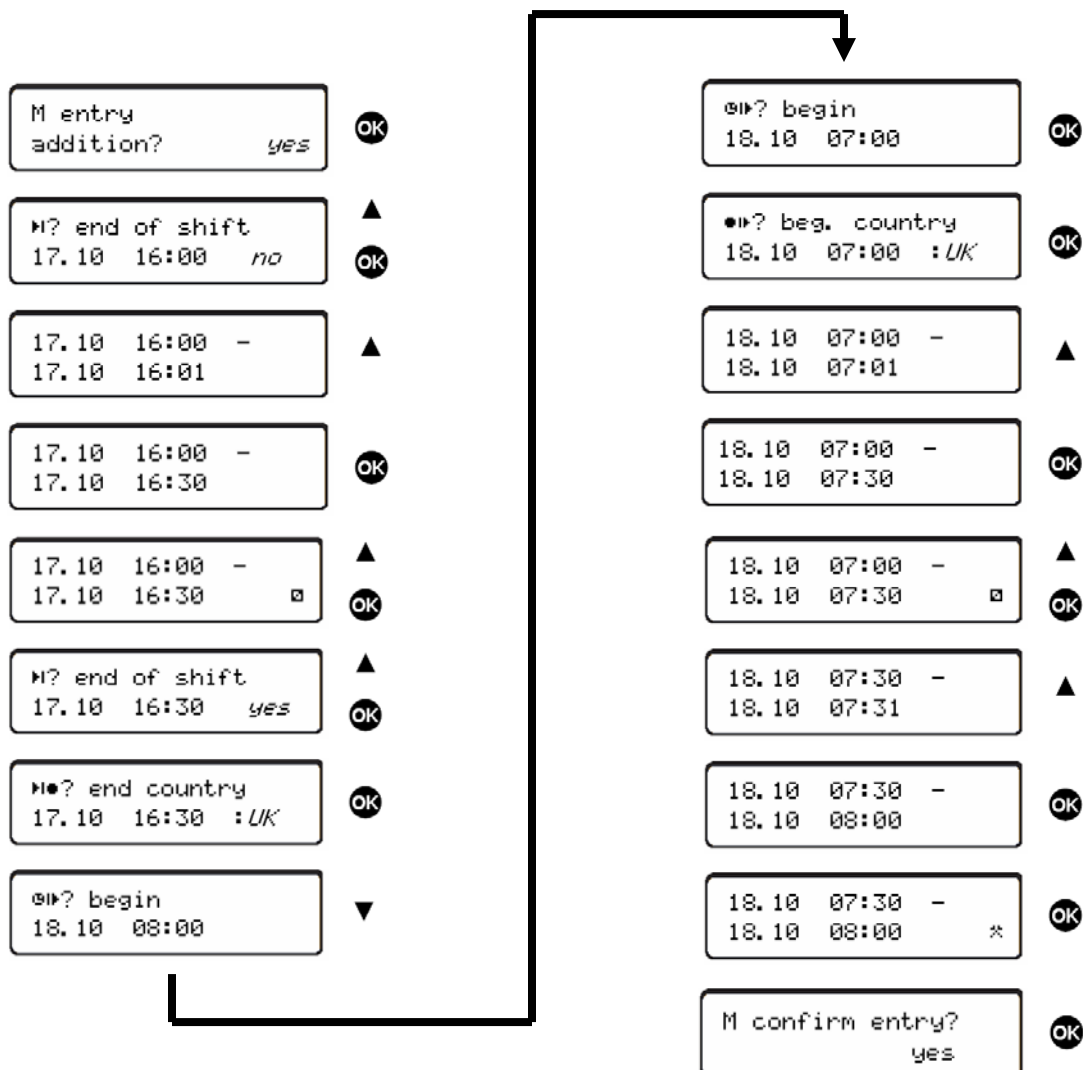
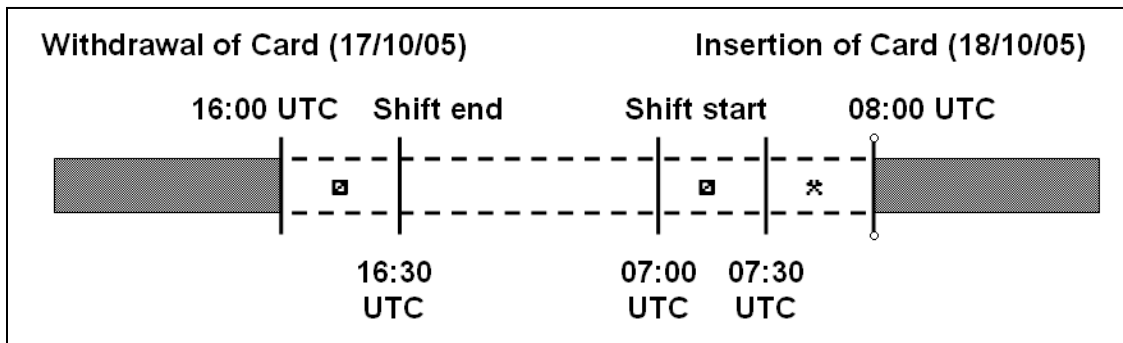

Driver Cards - Legal Requirements

First issue – Drivers should complete DVLA form D777B. The driver card is valid for 5 years and upon renewal the driver must apply not later than 15 days before expiry. The driver may hold one valid driver card only and is authorised to use only his own personalised driver card.

Lost or Stolen Card

If a driver card is lost or stolen, a replacement must be applied for within 7 calendar days. Stolen cards should be reported to the Police and DVLA. (DVLA tel no: 0870 8501074).

The driver must then at the start and end of the shift generate a daily printout from the digital tachograph and add personal information such as name and signature. Drivers' may continue to drive without a driver card for a maximum period of 15 days or for longer if this is necessary for the vehicle to return to its premises

Malfunctioning card

A Malfunctioning card should be returned to DVLA using form D777B

Replacement card

A replacement card must be collected from a DVLA local office or VOSA vehicle test station by the driver when it has been lost or stolen or exchanged. The driver should nominate where to collect the card and DVLA will write to the driver when the card is ready for collection. The driver must prove his identity by providing for example a passport or driving licence.

Where a driver card is damaged, malfunctions, or is lost or stolen the driver must:

(a) at the start of his journey, print out the details of the vehicle and shall enter onto that printout:

- (i) details that enable the driver to be identified (name, driver card or driver's licence number), including his signature;
- (ii) any mode entries prior to taking over the vehicle

(b) at the end of his journey, print out the information relating to periods of time recorded by the recording equipment, record any periods of other work, availability and rest undertaken since the printout that was made at the start of the journey, where not recorded by the tachograph, and mark on that document details that enable the driver to be identified (name, driver card or driver's licence number), including the driver's signature.

Tachograph checks during normal digital tachograph operation and mixed tachograph work:

When using a vehicle with an analogue tachograph a driver must be able to produce:

- the record sheets for the current day and those used by the driver in the previous 28 calendar days;
- the driver card if he holds one, and
- any manual record and legal printout made during the current day and the previous 28 calendar days as required (i.e. when a drivers card has been lost, stolen or malfunctions)

When using a vehicle with a digital tachograph a driver must be able to produce:

- the driver card of which he is holder;
- any manual record and legal printout made during the current day and the previous 28 calendar days as required (i.e. when a drivers card has been lost, stolen or malfunctions)
- the record sheets for the current day and those used by the driver in the previous 28 calendar days during when he drove a vehicle fitted with analogue recording equipment

Downloading Requirements

Driver Cards must be downloaded at least every 28 days and Digital Tachographs must be downloaded every 56 days, but in any case often enough to ensure that no data is lost. Downloading means copying the information from the Digital Tachograph and Driver Card – it does not delete it. The VU holds approx. 365 days and the driver card holds approx. 28 days of data, after which the oldest data is overwritten.

IMPORTANT: These brief instructions should not be regarded as a substitute for the DTCO 1381 instructions as prescribed by EU Regulation (EEC) no. 3821/85, Annex IB.

These instructions are for general guidance only and should not be regarded as a complete or authoritative statement of the law. Further information on legislation can be obtained from 561/2006 and 3821/85 (as amended) regulations.